



8 å # h 0
Silicon Content Technology

1

SCT61240
Rev.1.1



PIN FUNCTIONS (continued)

NAME	NO.	DESCRIPTION
AGND	5	Analog ground. AGND is the reference GND for the internal logic and signal circuit. AGND is not internally connected to Power Ground, make sure AGND connected to power ground in PCB.
LDOOUT	7	ceramic decouple capacitor between this pin and ground.
NR		

SCT61240

THERMAL INFORMATION(continued)

PARAMETER	THERMAL METRIC	QFN-18L	UNIT
R _B	Junction to board thermal resistance ⁽¹⁾	8.8	°C/W

ELECTRICAL CHARACTERISTICS

$V_{IN}=10V$, $T_A=-40^{\circ}C\sim 150^{\circ}C$, typical values are tested under $25^{\circ}C$.

SYMBOL	PARAMETER	TEST CONDITION	MIN	TYP	MAX	UNIT
Power Supply						
V_{IN}	Operating input voltage		4		19	V
V_{IN_UVLO}	Input UVLO Rising Threshold		3.6	3.8	3.95	V
	Hysteresis			200		mV
I_{SHDN}	Shutdown current from VIN pin	EN=0, no load		1	10	A
I_Q	Quiescent current from VIN pin	EN=3V, no load, non-switching		1	2	mA
$I_{Q_ACTIVE}^{(1)}$	Quiescent current from VIN pin	EN=3V, no load, switching		10		mA
Enable						
V_{EN}	EN rising threshold		1.1	1.2	1.3	V
	EN hysteresis			100		mV
I_{EN}	EN Pin Input Leakage	EN=5V, VIN=0V		0.01	1	A
Oscillator and Timing						
F_{SW}	Switching Frequency		2	2.2	2.4	MHz
F_{SS}	Spread Spectrum range		4	5	6	%
	Spread Spectrum frequency		3.5	4.3	5	kHz
T_{ON_MIN}	Minimum On Time			60		ns
T_{OFF_MIN}	Minimum Off Time			60		ns
T_{SS_BK1}	BUCK1 soft start time	$V_{OUT1}=3.1V$, from 0 to 100%		400		s
T_{SS_BK2}	BUCK2 soft start time	$V_{OUT2}=1.8V$, from 0 to 100%		400		s
T_{SS_BK3}	BUCK3 soft start time	$V_{OUT3}=1.2V$, from 0 to 100%		400		s
T_{SS_LDO}	LDO soft start time	$V_{OUT4}=2.8V$, $C_{NR}=100nF$, $C_{OUT}=10\ F$, $I_{LOAD}=100mA$		100	300	s
$T_{PG_delay}^{(1)}$	PG delay	Default setting		3.6		ms
T_{hiccup}	Hiccup time		2	3.6	5.2	ms

BUCK1 (HV BUCK)

V_{OUT1}	VOUT1 Output Voltage	SCT61240		3.3		V
		SCT61240-0000		$V_{LDO}+0.3$		
		SCT61240-0001		$V_{LDO}+0.5$		

V_{OUT1_ACC}

SCT61240

ELECTRICAL CHARACTERISTICS (Continued)

$V_{IN}=10V$, $T_A=-40^{\circ}C\sim 150^{\circ}C$, typical values are tested under $25^{\circ}C$

SYMBOL	PARAMETER	TEST CONDITION	MIN	TYP	MAX	UNIT
R_{DIS_BUCK1}	VOUT1 Output Discharge resistance		30	50	70	Ohm

BUCK2 (LV BUCK)

V_{IN23}	VIN23 Input Voltage Range		2.7		5	V
V_{OUT2}	VOUT2 Output Voltage			1.8		V
V_{OUT2_ACC}	VOUT2 Accuracy		-2		2	%
$R_{DS_H_BK2}$	High-side MOSFET on-resistance	$V_{OUT1}=3.1V$		155	260	m
$R_{DS_L_BK2}$	Low-side MOSFET on-resistance	$V_{IN}>5V$		75	125	m
$I_{LEAK_HS_BUCK2}$	SW2 HS Switch Leakage Current	$T_A=25^{\circ}C$		0.01	1	A
		$T_A=-40^{\circ}C\sim 150^{\circ}C$		7		A
$I_{LEAK_LS_BUCK2}$	SW2 LS Switch Leakage Current			0.01	1	A
I_{PEAK_BUCK2}	Peak Current Limit		0.9	1.2	1.65	A
I_{VALLEY_BUCK2}	Valley Current Limit		0.65	1	1.3	A
$I_{REVERSE_BUCK2}$	Reverse Current Limit		0.4	0.7	1	A
I_{LEAK_VOUT2}	VOUT2 PIN Leakage			1	10	A
R_{DIS_BUCK2}	VOUT2 Output Discharge resistance		30	50	70	Ohm

BUCK3 (LV BUCK)

V_{IN23}

ELECTRICAL CHARACTERISTICS (Continued)

$V_{IN}=10V$, $T_A=-40^{\circ}C\sim 150^{\circ}C$, typical values are tested under $25^{\circ}C$.

SYMBOL	PARAMETER	TEST CONDITION	MIN	TYP	MAX	UNIT
V_{DROP_LDO}	LDO Dropout Voltage	LDOIN=2.9V, setting LDO output =2.8V, ILDO = 300mA LDOOUT set to 2..16 Tm 531..4E		110	200	mV
LDO_LINE_REG	LDO Line Regulation					

TYPICAL CHARACTERISTICS

$V_{IN}=10V$, $T_A=-40^{\circ}C\sim 125^{\circ}C$, unless otherwise noted.

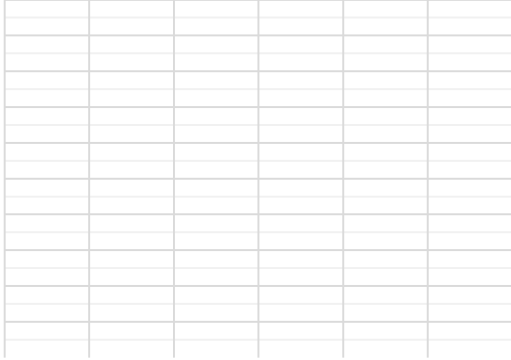

Figure 1. Buck1 Efficiency vs Load Current, $V_{OUT1}=3.2V$

Figure 2. Buck1 Efficiency vs Load Current, $V_{OUT1}=3.0V$

Figure 3. Buck2 Efficiency vs. Load Current, $V_{OUT2}=1.8V$

Figure 4. Buck3 Efficiency vs. Load Current, $V_{OUT3}=1.2V$

Figure 5. Buck3 Efficiency vs. Load Current, $V_{OUT3}=1.5V$

Figure 6. Buck1 Peak Current Limit vs. Temperature

FUNCTIONAL BLOCK DIAGRAM



OPERATION

Overview

The SCT61240 is a highly integrated power management IC (PMIC) optimized for camera system. It integrates three high efficiency synchronous BUCK converters (HVBUCK1, LVBUCK2, LVBUCK3), and a high-PSRR low noise LDO with OV/UV monitoring on all outputs.

VOUT1 is the output of BUCK1, which is powered from VIN (Power Over Coax) and can output 1.2A continuous current with the output voltage set to LDOOUT+300mV/500mV or fixed 3.3V.

VOUT2 is the output of BUCK2, which is powered from VOUT1 and can output 600mA continuous current with the output voltage fixed to 1.8V.

VOUT3 is the output of BUCK3, which is powered from VOUT1 and can output 1.2A continuous current with the output voltage set to 1.1V/1.2V/1.3V/1.5V through RSET PIN for different sensors.

LDOOUT is the output of LDO, which is powered from VOUT1 (need to connect LDOIN to VOUT1) and can output 300mA continuous current with the output voltage set to 2.7V/2.8V/2.9V/3.3V through RSET PIN for different sensors.

With a compact QFN2.5x3.5 package, the SCT61240 greatly reduces external components count and PCB space.

VIN and EN UVLO

When the VIN pin voltage rises above 3.8V and the EN pin voltage exceeds the enable threshold of 1.2V, the device is enabled. And the device disables when the VIN pin voltage falls below 3.8V or when the EN pin voltage is below 1.1V.

An internal 10M Ω resistor pulls EN pin to an internal 5V power supply allows the device to be enabled when EN pin is floating to simplify the system design.

High Efficiency Buck Converters

All the 3 BUCKs employ 2.2MHz fixed frequency peak current mode control with forced continuous conduction mode (FCCM). Built-in UVLO, soft-start (0.5ms/1ms/1.5ms/2ms options by OTP trim), compensation and hiccup (or latch off) (B)-9.1(or)-6.4 (V)-12.41.1 (V)-8.1(or)-6.0 (V) Tw 13.012 (V) Td (k)-20.1 (V) Tw (d).2Morrim/

SCT61240

Under Voltage Protection

If an output falls below the under voltage protection threshold, all outputs will shut off for the hiccup time. When hiccup ends, the normal power up sequence will start again according to the SEQ and RSET setting. When entry hiccup, the output discharge will operate during the hiccup time.

Over Current Protection (OCP)

For the three bucks and LDO, the SCT61240 provides both peak and valley current limit designed to limit the peak/valley inductor current to ensure that the switching currents remain within the device capabilities during overload conditions or during an output short circuit.

When the HS-FET turns on, the chip monitors the increased IL through the relevant operating main power switch. Once the peak IL exceeds the peak current limit threshold, the HS-FET turns off immediately, and the LS-FET turns on to conduct and decrease IL. The HS-FET does not turn on again until IL falls below the valley current limit threshold. If the feedback voltage makes EA's output level triggers the high clamp limit consecutively in a settled cycle, an over-current (OC) fault is reported and OCP is activated, all outputs will shut off for the hiccup time. When hiccup ends, the normal power up sequence will start again according to the SEQ and RSET setting.

Power Good

The PG pin is a push-pull output. It goes to logic high when the device is powered on, and all outputs are within the power good range, and no faults reported. The high output level can be programmed to either 3.3V or 1.8V.

PG will assert low when any of below events occur:

xBuck1's output is out of power good range or VOUT OV/UV range or OCP

xBuck2's output is out of power good range or VOUT OV/UV range or OCP

xBuck3's output is out of power good range or VOUT OV/UV range or OCP

xLDO's output is out of power good range or VOUT OV/UV range or OCP

xJunction temperature is over Thermal Shutdown point

xVIN is higher than VIN OVP threshold

Hiccup or Latch off Protection

When below faults are detected, the SCT61240 will enter hiccup or latch off mode (programmable option). When select hiccup mode and entry hiccup, all the channels shut off for 3.2ms, and then the normal power up sequence will start again according to the SEQ and RSET setting. When select latch off mode and entry latch off, all the channels shut off and not restart unless VIN/EN power on reset (POR).

The faults that make the device entry hiccup/latch off protection:

xBuck1's output is out of VOUT OV/UV range or OCP

xBuck2's output is out of VOUT OV/UV range or OCP

xBuck3's output is out of VOUT OV/UV range or OCP

xLDO's output is out of VOUT OV/UV range or OCP

xJunction temperature is over Thermal Shutdown point

x

the reference voltage takes over.

Frequency Spread Spectrum

To meet CISPR and EMI compliances, the SCT61240 implements Frequency Spread Spectrum (FSS) function. The FSS circuitry shifts the 2.2MHz switching frequency within $\pm 5\%$ range and $1/512$ of the switching frequency periodically. Therefore, the SCT61240 can guarantee that the switching frequency does not drop into the 1.8MHz AM band limit.

Thermal Shutdown

The SCT61240 protects the device from damage during excessive heat and power dissipation condition. Once the junction temperature exceeds 170C, the thermal sensing circuit disable all channels and enter hiccup or latch off. When the junction temperature falls below 150C and hiccup ends, then the device restarts.

Power on/off Sequence Control

For power on, the SCT61240 supports 6 power-on sequences for buck2&3 and LDO through SEQ pin. Since the output of BUCK1 is the power for the next three channels, BUCK1 is always set to startup first.

For power off, through VIN/EN or entry hiccup/latch off, all channels power off simultaneously.

Connect a resistor between SEQ and GND to set the power on sequence before enabling the device. The SEQ detection only activated at the beginning of power on, and the sequence configuration is latched once SEQ detection done. When the resistance selected out of range, CH2&CH3&CH4 are disabled. Any change during the power on procedure is not guarantee to the correct power-on sequence.

Below table shows the power-on sequence with its corresponding resistance. CH1 is BUCK1, CH2 is BUCK2, CH3 is BUCK3, CH4 is LDO.

Table 1. Power-On Sequence Control

SEQ No.				Sequence			
	MIN	TYP	MAX				
SEQ1	0	0	3k	CH1	CH4	CH2	CH3
SEQ2	6k	8k	10k	CH1	CH2	CH4	CH3
SEQ3	14k	16k	18k	CH1	CH2	CH3	CH4
SEQ4	24k	27k	30k	CH1	CH3	CH2	CH4
						CH4	CH2

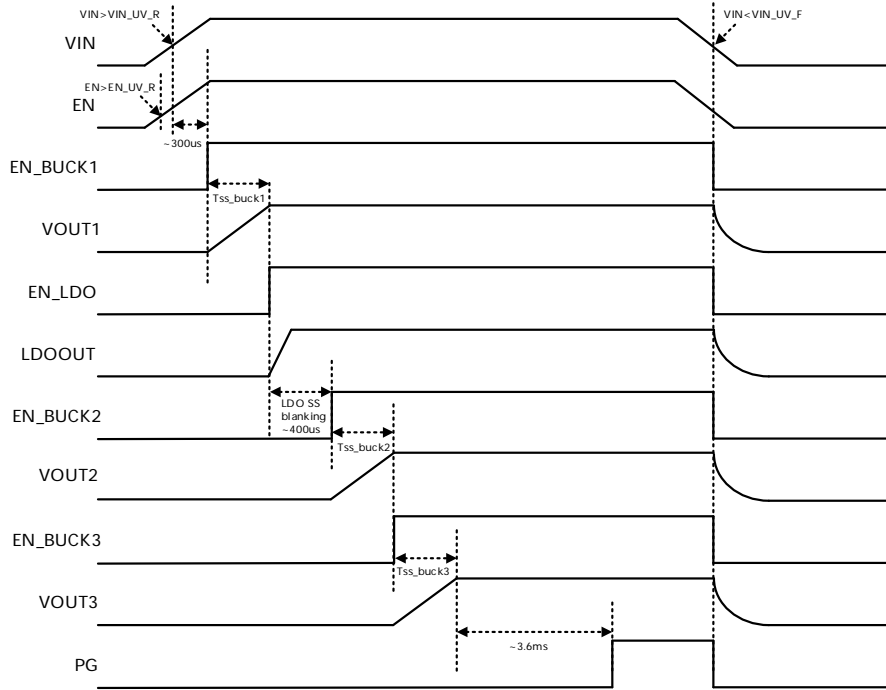

Figure 12. Example SEQ1 for SCT61240

Output Voltage Setting

The device provides 9 flexible voltage setting through RSET PIN for various sensors. Connect a resistor between RSET and GND to set the output voltage of each channel before enabling the device. The RSET detection only activated at the beginning of power on, and the output voltage configuration is latched once RSET detection done. Any change during the power on procedure is not guarantee to the correct output voltage setting.

Below table shows the output voltage setting with its corresponding resistance.

Table 2. Output Voltage Setting

RSET
No. RSET Resistance(

APPLICATION INFORMATION

Typical Application

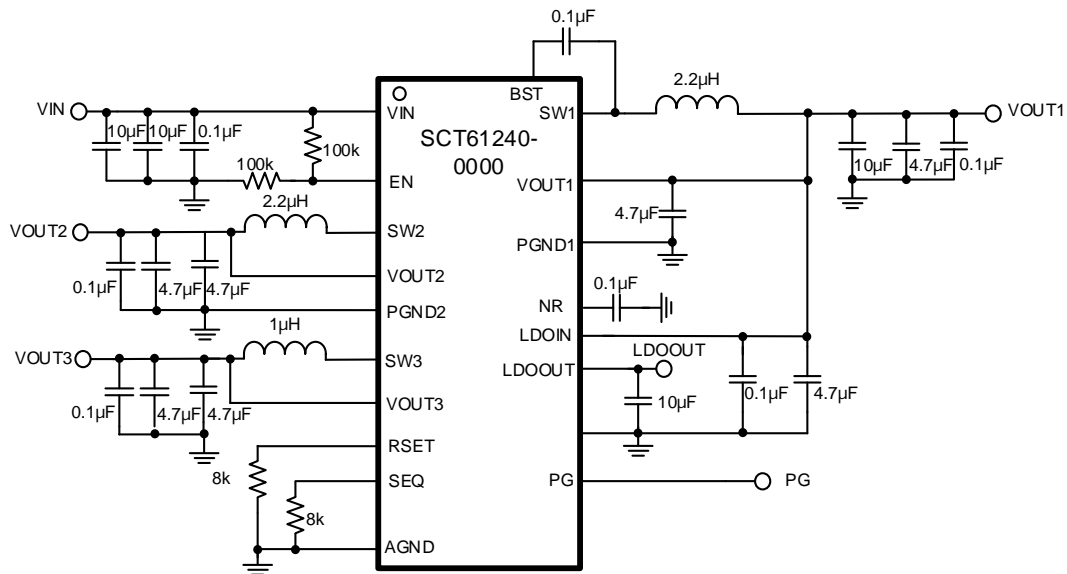

Figure 13. Application Schematic, 4V to 19V, PMIC Regulator at 2.2MHz

Design Parameters

Design Parameters	Example Value
Input Voltage	10V Normal 4V to 19V
Output Voltage	VOUT1: 3 LDOOUT: 2.7V
Maximum Output Current	VOUT1: 1.2A LDOOUT: 0.3A
Switching Frequency	2.2MHz
Output Voltage Ripple (peak to peak)	VOUT1: 1 VOUT3: 4m

Under Voltage Lock -Out

An external voltage divider network of R_1 from the input to EN pin and R_2 from EN pin to the ground can set a higher input voltage's Under Voltage Lock-Out (UVLO) threshold. The UVLO has two thresholds, one for power up when the input voltage is rising and the other for power down or brown outs when the input voltage is falling. Use Equation 1 and Equation 2 to calculate the values of R_1 and R_2 resistors.

- x $V_{IN(max)}$ is the maximum input voltage
- x $I_{OUT(max)}$ is the maximum DC load current
- x LIR is coefficient of I_{LPP}

Application Waveforms

$V_{in}=10V$, $R_{SET}=SEQ=8k$, $V_{OUT1}=3.0V$, $V_{OUT2}=1.8V$, $V_{OUT3}=1.2V$, $V_{OUT4}=2.7V$, unless otherwise noted

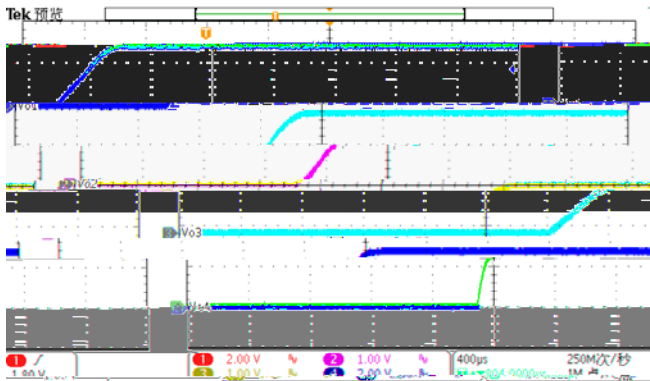

Figure 15. Power On (Io2=0.6A, Io3=1.2A, Io4=0.3A)



Figure 16. Power Off (Io2=0.6A, Io3=1.2A, Io4=0.3A)

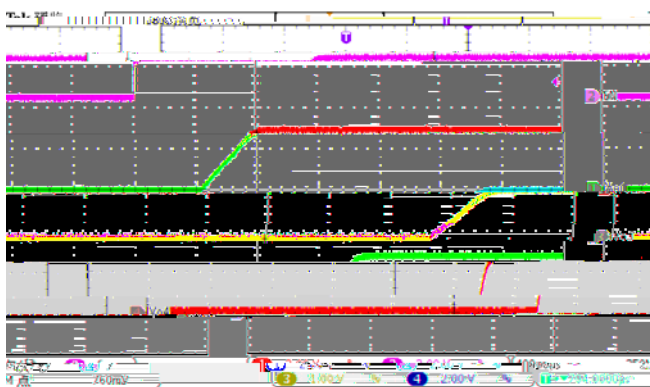

Figure 17. EN On (Io2=0.6A, Io3=1.2A, Io4=0.3A)

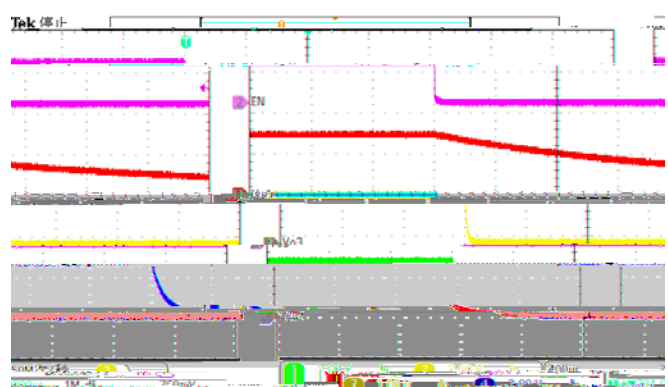

Figure 18. EN Off (Io2=0.6A, Io3=1.2A, Io4=0.3A)

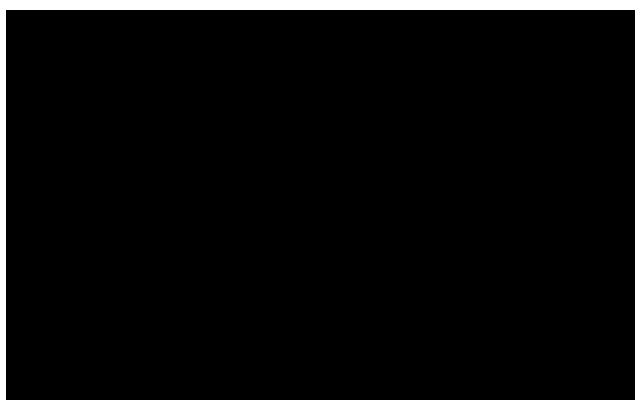

Figure 19. Buck1 Over Current Protection
(1.2A to hard short)

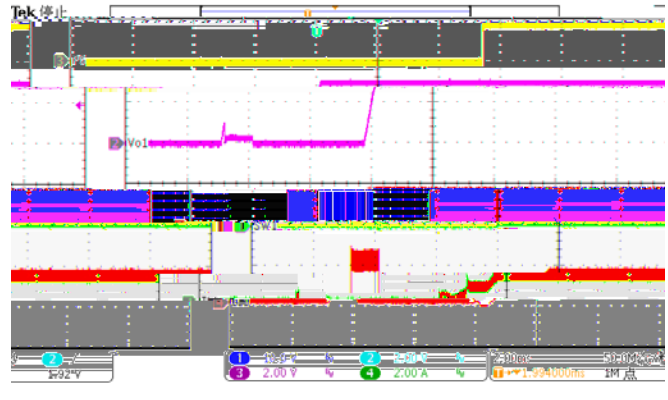

Figure 20. Buck1 Over Current Release
(hard short to 1.2A)

SCT61240

Application Waveforms (continued)

$V_{in}=10V$, $R_{SET}=SEQ=8k$, $V_{OUT1}=3.0V$, $V_{OUT2}=1.8V$, $V_{OUT3}=1.2V$, $V_{OUT4}=2.7V$, unless otherwise noted

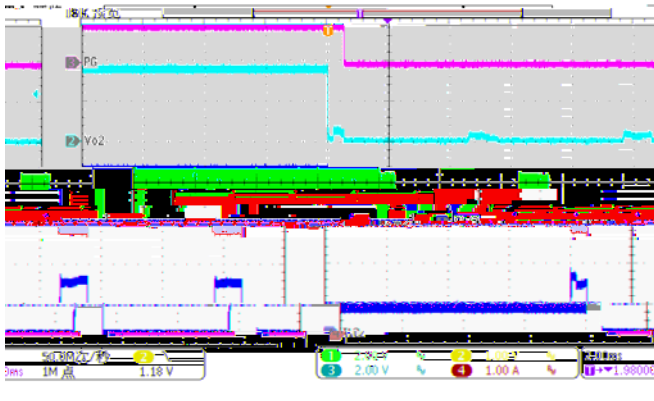

Figure 21. Buck2 Over Current Protection
(0.6A to hard short)

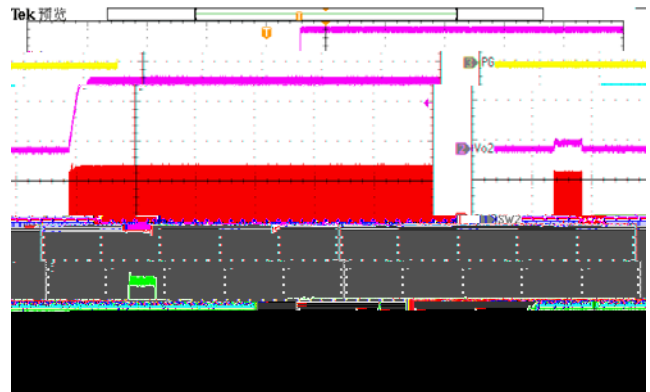

Figure 22. Buck2 Over Current Release
(hard short to 0.6A)

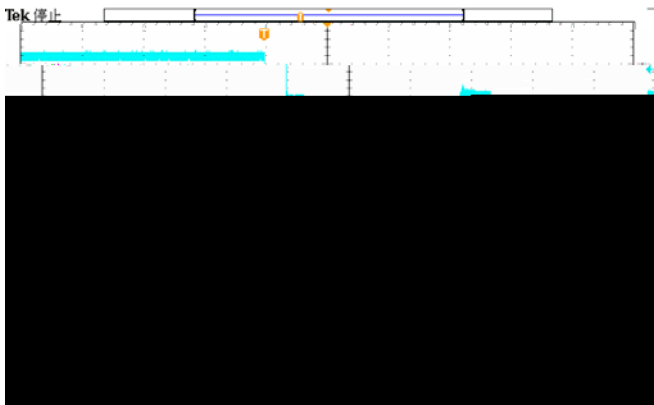

Figure 23. Buck3 Over Current Protection
(1.2A to hard short)

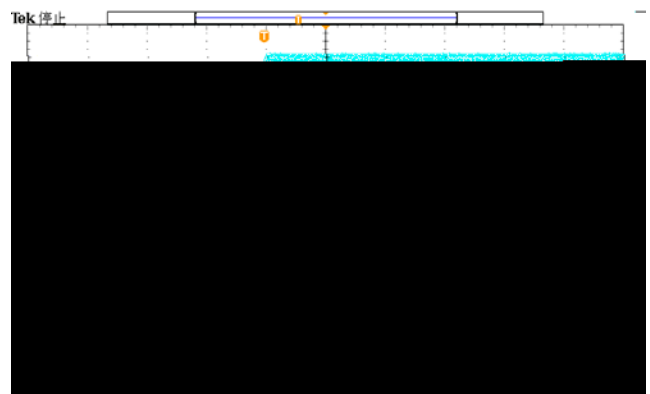

Figure 24. Buck3 Over Current Release
(hard short to 1.2A)

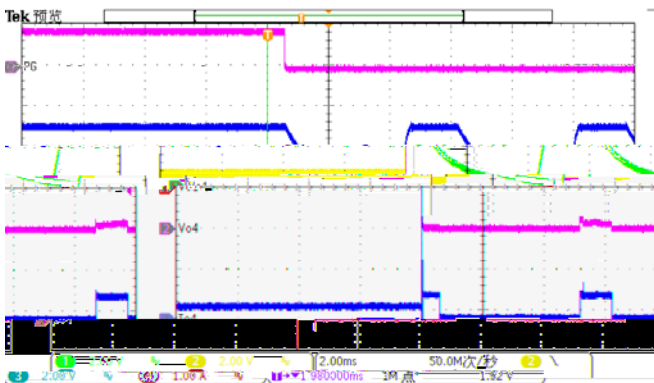

Figure 25. LDO Over Current Protection
(0.3A to hard short)

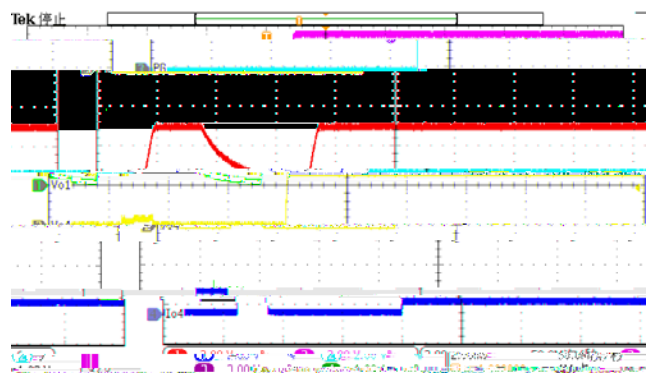

Figure 26. LDO Over Current Release
(hard short to 0.3A)

SCT61240

Layout Guideline

Proper PCB layout is a critical for SCT61240's stable and efficient operation. The traces conducting fast switching currents or voltages are easy to interact with stray inductance and parasitic capacitance to generate noise and degrade performance. For better results, follow these guidelines as below:

1. Power grounding scheme is very critical because of carrying power, thermal, and glitch/bouncing noise associated with clock frequency. The .2 (2u4 (m)-24.b(ed))TJ 0 Tc 0 Tw ()Tj -0.002 Tc 0.11 3 -1.112 0 Td3 (of)-13.2 ()0.1 (r)-

PACKAGE INFORMATION

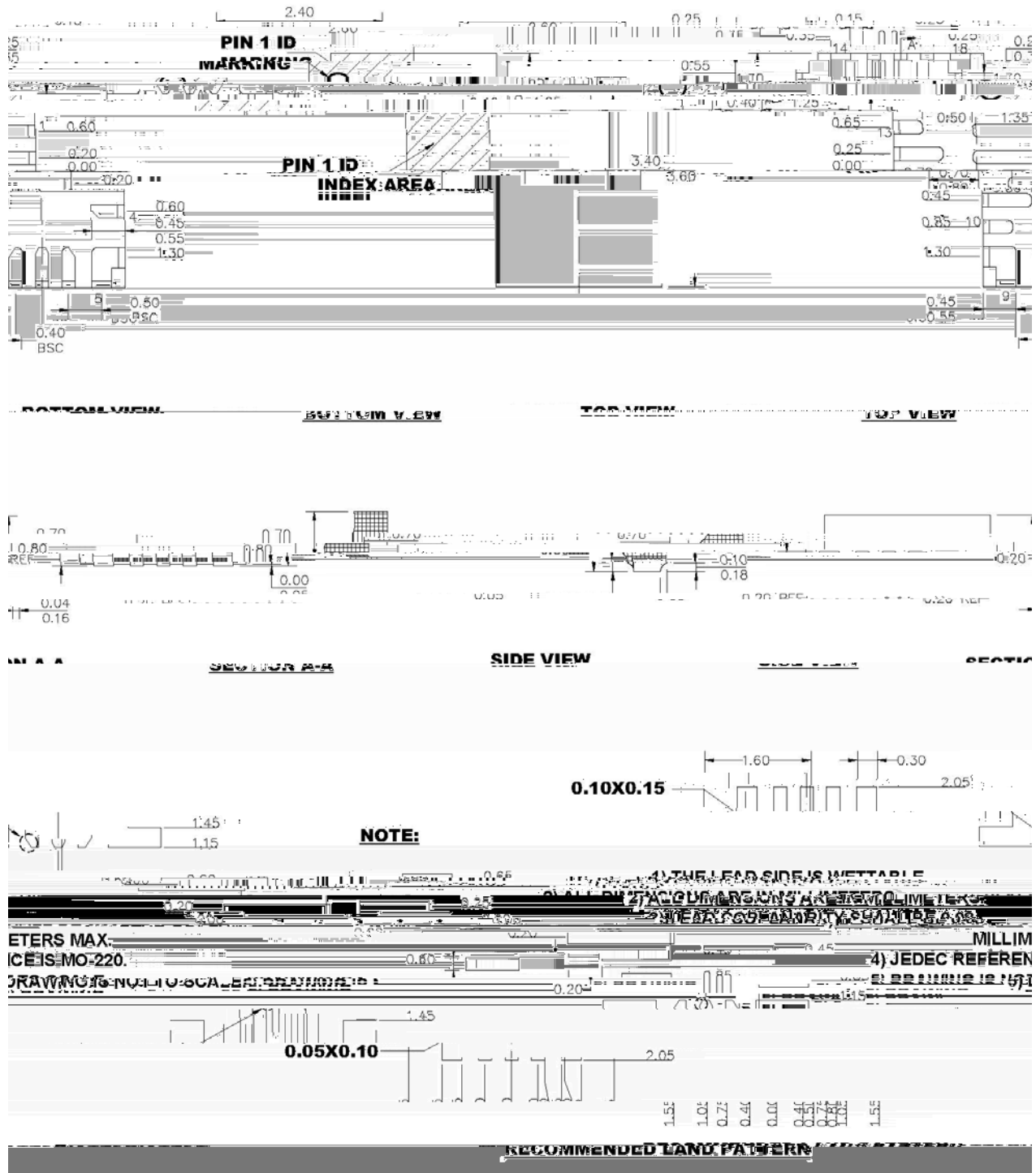

TAPE AND REEL INFORMATION

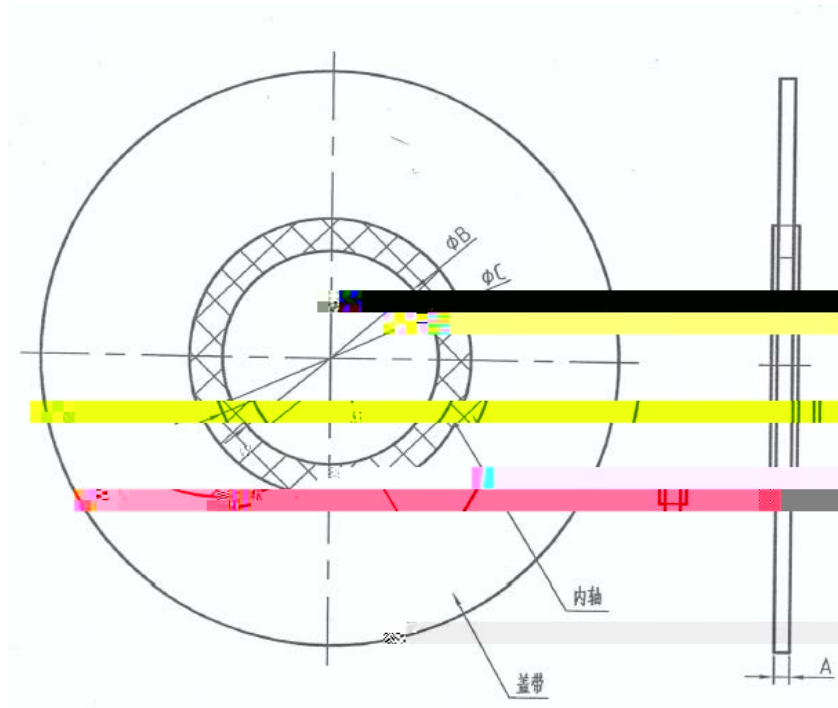

Type	A ₀ ^{+0.1} mm	Carrier Width	Diameter
PRA F4DK	9.3	12	B=76.2±0.10mm C=92.2±0.25mm
HST	9.5	12	
HST	13.5	16	
HST C800	21.3	24	
2420S	13.3	16	
2420S	21.3	24	
TIST300	9.9	12	

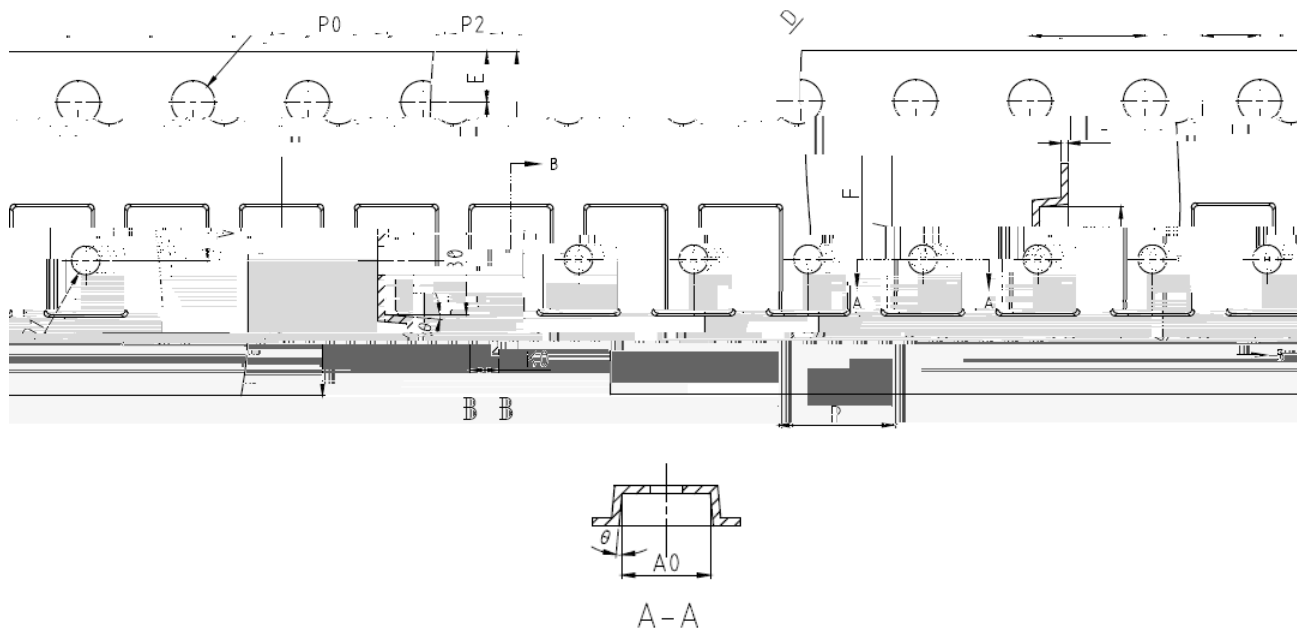

Symbol	Dimensions in Millimeters
A0	2.75±0.10
B0	3.75±0.10
D	1.5 ^{+0.10}
D1	1.00±0.10
E	1.75±0.10
F	5.50±0.05
K0	1.00±0.10
P	4.00±0.10
P0	4.00±0.10
P2	2.00±0.05
t	0.25±0.03
W	12.00 ^{+0.30} _{-0.10}
	5° max